

CONTACT

www.bradleycollection.com



UK & REST OF THE WORLD

+44 (0)1449 722 724

info@bradleycollection.com

USA & CANADA

+1 (310) 815 8255

info.us@bradleycollection.com

LONDON SHOWROOM

+44 (0)207 871 7793

showroom@studiotwochelsea.com

9 | THE BRADLEY COLLECTION

THE BRADLEY COLLECTION



CEDIA
MEMBER

Specialised fixings for mounting brackets will be required in certain situations and are not provided as standard.
Steel items are not recommended for damp conditions such as shower rooms.
Crystal finials should not be positioned in direct sunlight, and are not suitable for use in conservatories.
Fluid Metal items are supplied unlacquered and will tarnish over time.

The Bradley Collection reserves the right to modify design and materials without prior notice as part of a process of continual product improvement. Due to printing limitations, colours in this brochure may not be accurate.

Products are protected by Design Rights, under provisions of Copyright, Designs & Patents Act 1988.
Bradley®, The Bradley Collection® and  Logo are registered Community trademarks of The Bradley Collection Ltd. in Europe and registered trademarks of the Bradley Collection, Inc. in the USA.

The Bradley Collection Ltd Lion Barn • Maitland Road • Needham Market • Suffolk • IP6 8NS • UK

Printed: 1024 • Copyright © The Bradley Collection Ltd. 2024

EDITION 9 ELECTRIC

23 | 25

THE BRADLEY COLLECTION

EDITION 9 ELECTRIC

23 | 25

ELEVATE

Picture: ø38mm (1½") Coverpole - Lutron - Standard Stud - Flint - Satin
Window treatments: Ace Contracts - Essex - UK | www.acecontracts.com

⚡ | ELECTRIC
Page:01-08

⚡ | DRIVE
Page:09-112

⚡ | ELEVATE
Page:14-16

⚡ | ELEVATE WOOD
Page:15-20

⚡ | LINEAR
Page:21-24

STUNNING ELECTRIC CURTAIN POLES

DESIGNED AROUND

 **LUTRON**

 **somfy**

 **SilentGliss**

Our decorative systems may be specified with your choice from the leading motorised brands.

This provides power and control options ranging from standalone battery powered systems to fully integrated home automation solutions.



MOTOR OPTIONS

Systems may be specified with your preferred choice of track, motor and control system. Specify from the drives from Lutron, Somfy or Silent Gliss.



Low voltage concealed motors
 Three motor ratings for differing curtain weights
 Quiet motors, noise level at 1000mm (3') <44dBA
 Fully compatible with Lutron® QS Home Automation systems

⚡ Motor



D105 • D145 • D175
 Mains powered motor options. Requires professional installation.
 Suitable for systems up to 9M (29.5ft)Ⓞ.

⚡ Motor with radio dongle



D105 • D145 • D175
 Mains powered motor options, with radio dongle for use with remote control options.
 Requires professional installation.
 Suitable for systems up to 9M (29.5ft)Ⓞ.



Mains & Battery powered motor options
 Touch and go manual operation
 System allows manual operation during power failure
 Quiet motors, noise level at 1000mm (3') <44dBA
 Fully compatible with Somfy RTS

🔋 Movelite 35 WFⓄⓄ



RTS
 Battery powered motor, with integrated radio receiver for use with remote control options.
 Single charge lasts up to four months.
 Requires no pre-wiring.
 Suitable for systems up to 6M (19ft)Ⓞ.

⚡ Movelite 35Ⓞ



WT • RTS
 Mains powered motor.
 RTS includes integrated radio receiver for use with remote control options.
 Requires professional installation.
 Suitable for systems up to 10M (33ft)Ⓞ.

🔋 Irisimo 45 WF



RTS
 Battery powered motor, with integrated radio receiver for use with remote control options.
 Single charge lasts up to six months.
 Requires no pre-wiring.
 Suitable for systems up to 10M (33ft)Ⓞ.

⚡ Glydea Ultra 60e



WT • RTS
 Mains powered motor.
 RTS includes integrated radio receiver for use with remote control options.
 Requires professional installation.
 Suitable for systems up to 12M (39ft)Ⓞ.



Smooth, silent and powerful motors
 DC & AC hidden motor options
 Touch and go manual operation
 System allows manual operation during power failure
 Quiet motors, noise level at 300mm (1') <36dBA

⚡ 9060 Motor



Mains & low voltage powered motor option.
 Requires professional installation.
 Suitable for systems up to 15M (49ft)Ⓞ.
 Three colour options: White • Silver • Black

⚡ 9060 Motor with radio module



Mains powered motor, with radio module for use with remote control options.
 Requires professional installation.
 Suitable for systems up to 15M (49ft)Ⓞ.
 Three colour options: White • Silver • Black
 Smart Expansion ModuleⓄ also available.

CONTROL OPTIONS

Motors from the three motorised brands allow systems to be used with your choice of individual remote control, Smart home app control or any of the major home control systems.

REMOTE CONTROL

Motors with radio receivers can be controlled wirelessly with compatible remote control options.



Lutron
 Single Channel



Somfy
 Single Channel & Multi Channel options



Silent Gliss
 Single Channel & Multi Channel options

APP CONTROL

With the addition of a compatible hub. Systems with radio receivers can be controlled via app or through smart devices & Amazon AlexaⓄ.



Lutron
 RA2 Select Hub

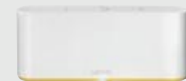

Somfy
 Tahoma



Silent Gliss
 Move

AUTOMATION SYSTEMS

Systems can also be intergrated with all major home control systems.Ⓞ



⚡ Mains Power | 🔋 Battery Power | Ⓞ Supplied in sections - maximum section apply | Ⓞ Only available in Europe | Ⓞ Movelite35 WF is not suitable for bay bends
 Ⓞ Brushed finishes not available with bends
 Weight restrictions apply. For full technical information please refer to the specification guide. www.bradleycollection.com/specification-guides/

Ⓞ Specialist support & additional components required
 Ⓞ Smart only available in United Kingdom, requires Smart Expansion Module

Ⓞ Move server not compatible with voice control

FINISHES

All poles and components may be specified in this stunning palette of colours and finishes, with a choice of coat options throughout.

SHADES AVAILABLE ON ● ● ● ●

A superb selection of opaque colours, all available in a choice of Matte, Satin or Gloss finish.

COAT OPTIONS



METALLICS AVAILABLE ON ● ● ● ●

High metallic fleck coatings with most available in Satin and Gloss sheen levels.

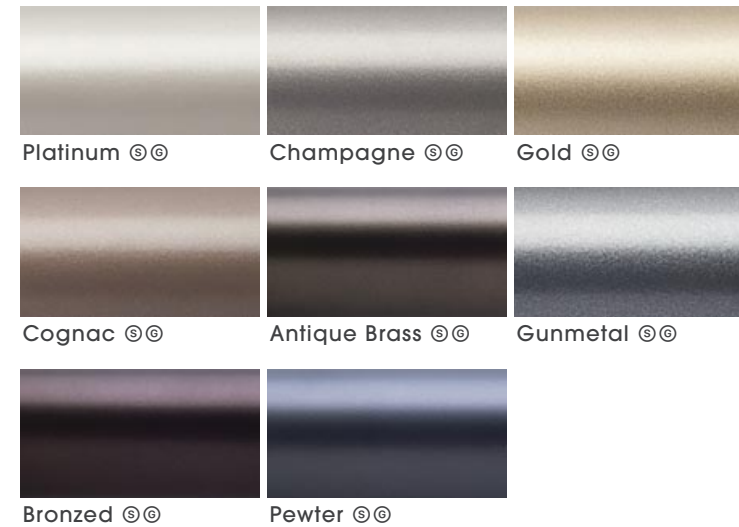

ANODIC METALS AVAILABLE ON ● ● ● ●

A flat metal colour group, with an anodised style surface texture.



STAINLESS STEEL AVAILABLE ON ● ●

A brushed stainless steel base gives an edgy feel.



CLASSICS AVAILABLE ON ●

Signature translucent finishes which allow the beauty of steel to shine through.

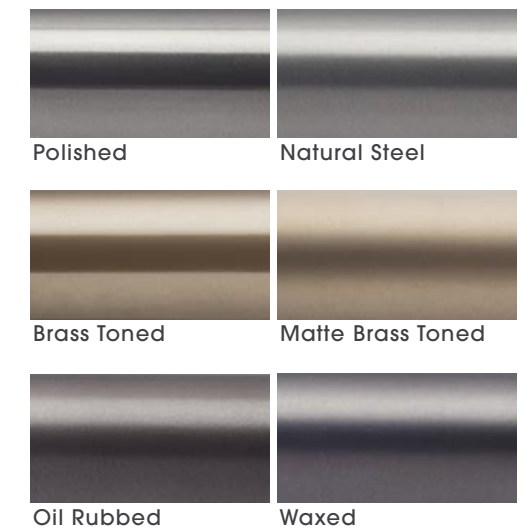

WOOD AVAILABLE ON ●

Authentic ash poles available in low sheen natural and black finish. ⊗

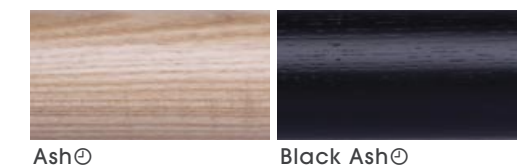



SPECIALIST FINISHES

Specialist techniques are employed to deliver additional finish choices. These more complex finishes are available at a premium cost and with longer lead times.

STAINLESS TINTS AVAILABLE ON ● ●

Brushed stainless steel, in subtle tinted hues gives an industrial aesthetic.

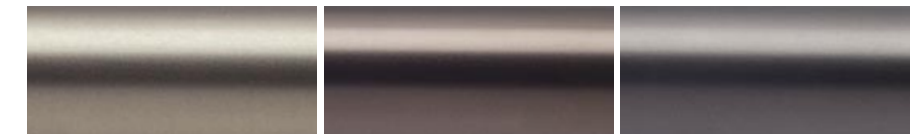

Brushed Brass ⊕⊕⊗

Brushed Bronze ⊕⊕⊗

Brushed Carbon ⊕⊕⊗

FLUID METAL™ AVAILABLE ON ● ● ●

Leading edge technology allows authentic metal coats to be applied to any substrate, which can then be worked and aged for a truly luxurious result.



Old Brass ⊕⊕⊗👉

Light Bronze ⊕⊕⊗👉

Bronze Art ⊕⊕⊗👉

PREMIUM WOOD AVAILABLE ON ●

Authentic cherry, walnut and oak, available in low sheen natural finish.



Oak ⊕⊕

Cherry ⊕⊕

Walnut ⊕⊕

AVAILABLE ON: ● DRIVE | ● ELEVATE | ● ELEVATE WOOD | ● LINEAR

⊕ A finishing charge will apply | ⊗ Longer lead-times will apply | ⊗ Fluid Metal finishes are supplied unlacquered and will tarnish over time, a clear lacquer may be applied on request as a custom finish

👉 Fluid Metal finishes are hand produced, finish may vary | ⊕ Brushed finishes not available with bends



⚡ | DRIVE

Pictured: Round ø38mm (1½") ⚡Pole • Ellipse • Glimmer

⚡ | DRIVE

Innovative and exciting, Drive brings curtain poles firmly into the modern era. A full round pole style, a seamless look and a solution for any shape of window; all driven by your choice of drive and control.



DRIVE | THE NEW STANDARD

For more information on Drive please visit www.bradleycollection.com/drive/

SEAMLESS INNOVATION

The motor is turned through 90 degrees and rear-mounted via an embedded motor housing, finished in a complementary colour. The motor sits neatly and discreetly behind the drapes.

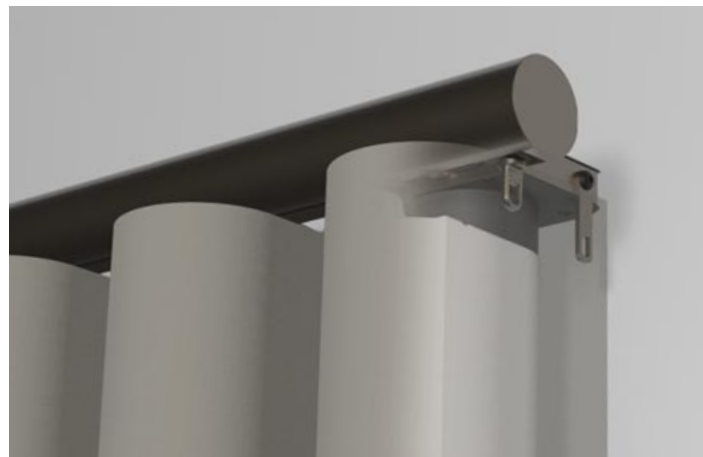

GLIDING

Gypsum & Anthracite material now offered as standard for gliders, with coated metal gliders available for an exact colour match.



MODERN

Modern sinuous heading styles can be created, using both hook and tape or snap tape components.

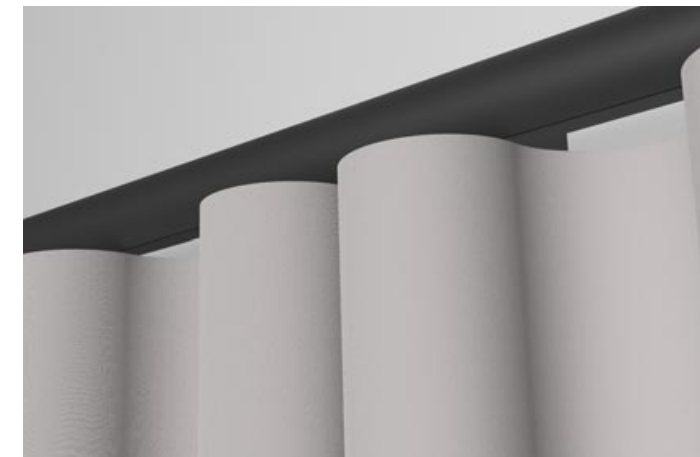

UNOBTRUSIVE

The clever bracket design keeps the front face of the pole clear of visible parts.



PRECISE

A new jointing system ensures perfect alignment between pole sections.

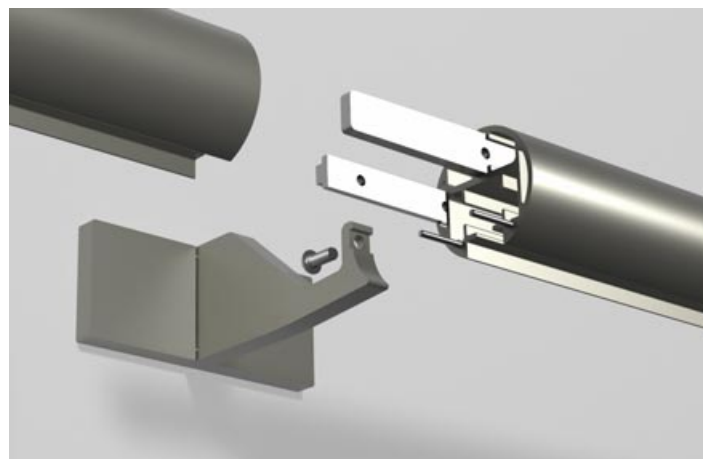

FLUSH

The rear fixing brackets allow true flush ceiling mount for the first time.



BENT TO SHAPE

The pole is designed to be accurately bent and curved to shape.





⚡ | ELEVATE

Pictured: ø38mm (1½") Coverpole - Lutron • Standard Stud • Brass Toned
Project by: Gallagher London • London SW7 - UK

Peerless and opulent, this collection truly has no rival.

Elevate combines a decorative coverpole with your choice of track and drive system. Coverpole, track and brackets are coated to complement one another perfectly.

The result is a unified electric pole with power and control options ranging from standalone battery powered systems to fully integrated home automation solutions.

For more information on Elevate please visit www.bradleycollection.com/elevate/

LENGTH

Poles can be supplied to any length[Ⓜ], subject to maximum weight loadings of the selected motorised system.



BENT TO SHAPE

A bespoke bay bending service is available on all diameters to allow the perfect shaped pole to fit any bay window.[Ⓜ]



FUNCTION

A range of bracket options have been designed to ensure simple installation, including flush fit ceiling brackets.

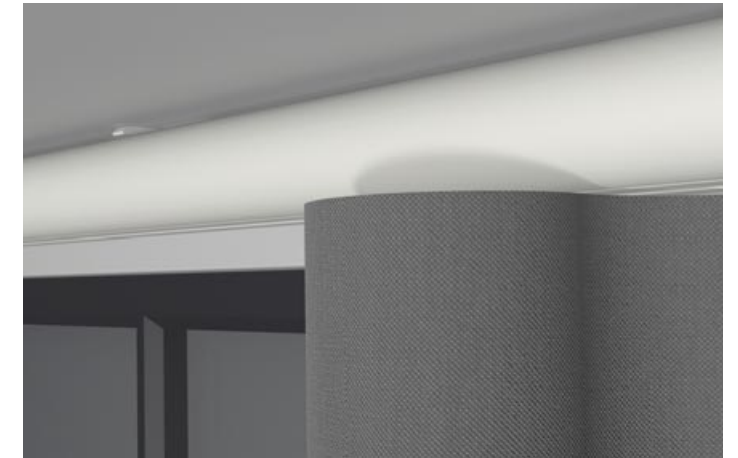

SCALE

Elevate poles are available in two pole diameters, Ø38mm (1½") • 50mm (2"). Finial designs are carefully scaled to maintain the system aesthetic.



DETAILING

The secret of any design is in the detail. Nylon end housings are finished in a complementary colour, for a harmonious tonal effect.



MODERN HEADINGS

The choice of motor systems means that modern headings can be accommodated, with both Wave[®] and Ripplefold[®] styles available.



EDGE

Edge is the epitome of understatement, being sleek, discreet and integrated. The unique Edge bracket design gives a structured return to the wall for drapes.

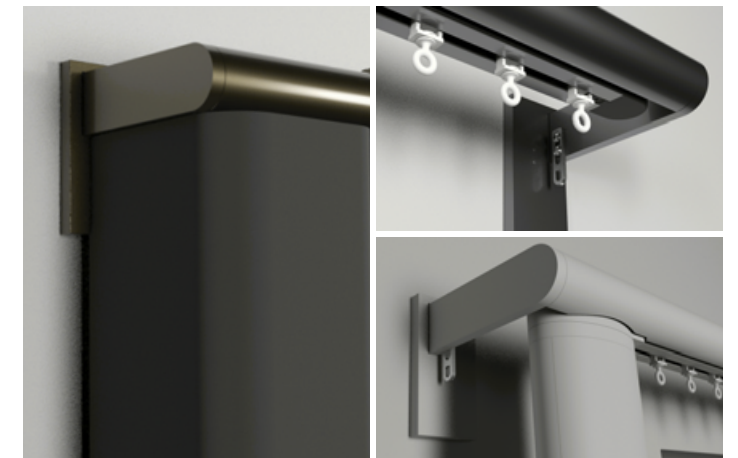



⚡ | ELEVATE WOOD

Pictured: ø50mm (2") Coverpole - Lutron · Walnut
Contrast Stud Stud · Brushed Brass Tint

⚡ | ELEVATE WOOD

Wooden poles re-imagined for the modern age. Solid, natural wood covers conceal state of the art electric track systems.

A stunning aesthetic and smart living combined.

For more information on Elevate Wood please visit www.bradleycollection.com/elevate-wood/

MATERIALS

Elevate Wood is available in a selection of fine woods, presented in a contemporary low sheen finish.



DETAILING

The secret of any design is in the detail. Elevate Wood includes join covers and complementary finish to nylon end housings, for a harmonious tonal effect.



LENGTH

Poles can be supplied to any length[Ⓞ], subject to maximum weight loadings of the selected motorised system.



FUNCTION

A range of bracket options have been designed to ensure simple installation, including flush fit ceiling brackets.



BENT TO SHAPE

A bespoke bay bending service is available to allow the perfect shaped pole to fit any bay window.

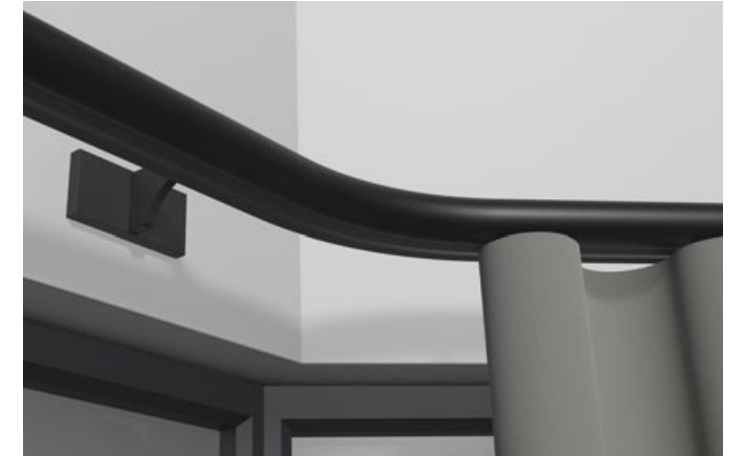

MODERN HEADINGS

The choice of motor systems means that modern headings can be accommodated, with both Wave[®] and Ripplefold[®] styles available.





⚡ | LINEAR

Pictured: Lutron System • Raven - Matte

⚡ | LINEAR

Linear transforms a mundane but functional electric track into a high end design statement. Available in a wide range of coated finishes, with metal end housing covers and superior bracket styling. Smart tech meets sharp design.

For more information on Linear please visit www.bradleycollection.com/linear/

DETAILING

Nylon end housings are painted in a complementary colour and then concealed within shaped metal covers, coated to match the track exactly.



LENGTH

Tracks can be supplied to any length[Ⓜ], subject to maximum weight loadings of the selected motorised system.



BENT TO SHAPE

A bespoke bay bending and curving service is available on all systems to allow the perfect shaped track to fit any bay window.

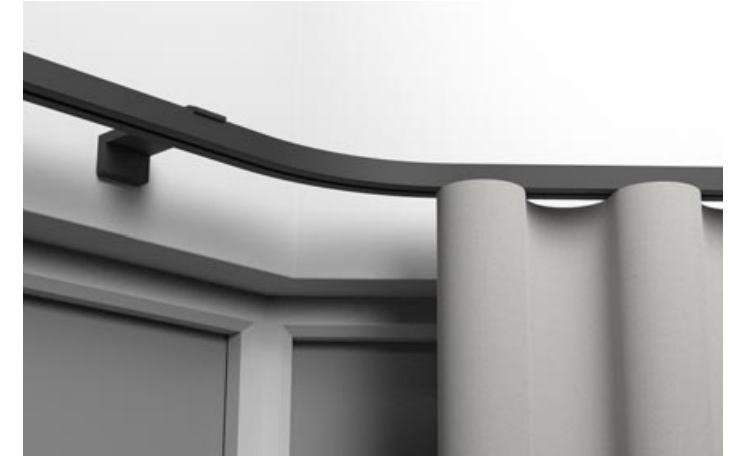

FUNCTION

Superb wall brackets may be specified in a matching coated finish and incorporating signature Bradley details such as magnetic cover plates.



MODERN HEADINGS

The choice of motor systems means that modern headings can be accommodated, with both Wave[®] and Ripplefold[®] styles available.

